

*Insignia Collection*

Luxury Glass Door Hinges

DATA SHEET WG1144 Central Mount

## Glass Door Hinge Wall-to-Glass Fixing, Central Mounted with Adjustable Closing Lotus Style#1 Clamp Plates



Material : Stainless Steel AISI 304

Weight : 2.1 kg

Finish : See Finish Options

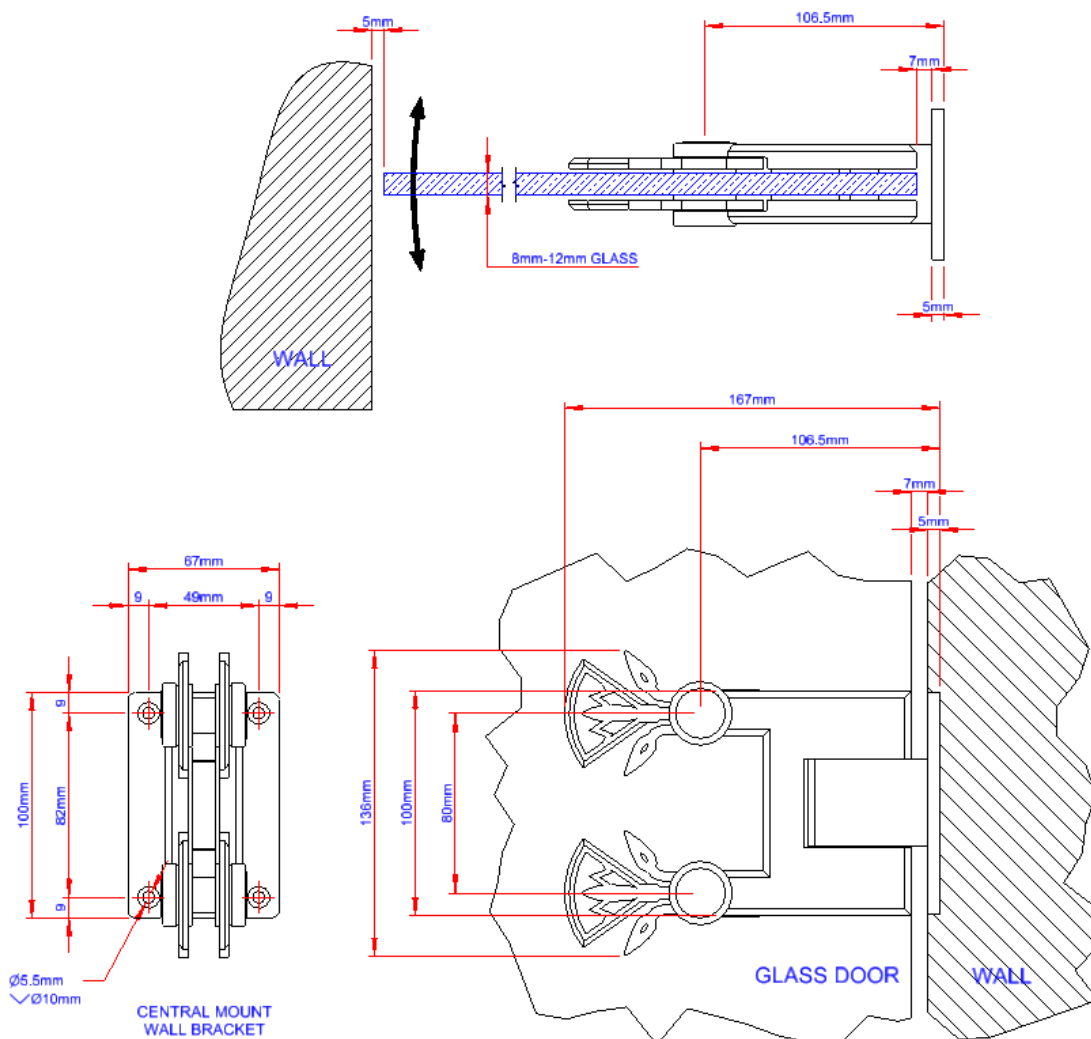

Insignia Collection

Luxury Glass Door Hinges

DATA SHEET WG1144 Central Mount

Glass Door Hinge Wall-to-Glass Fixing, Central Mounted with Adjustable Closing Lotus Style#1 Clamp Plates

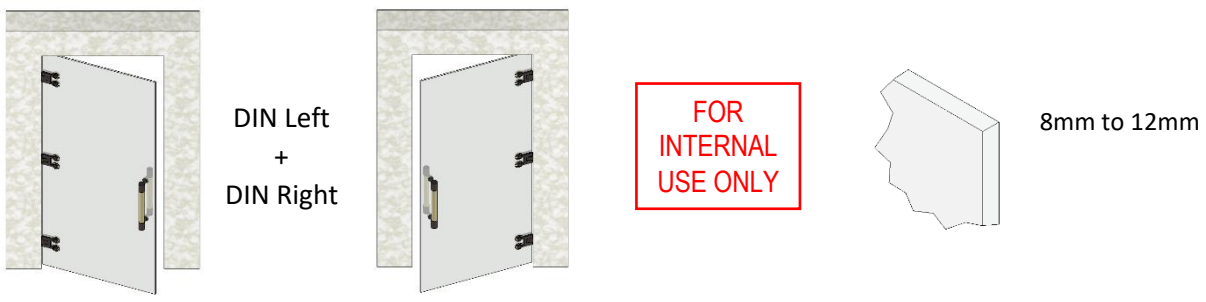

Maximum Load Weights

Maximum Glass Door Widths

Recommended Hinge Spacing

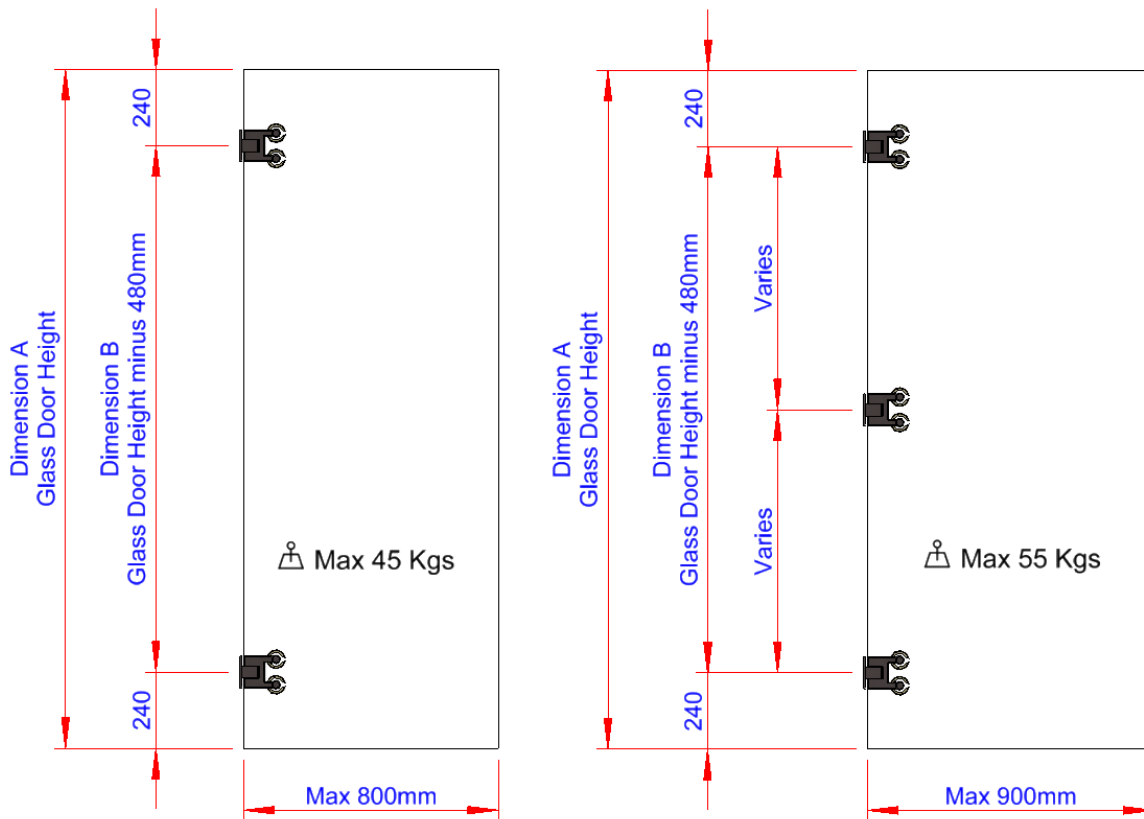

*Insignia Collection*

Luxury Glass Door Hinges

DATA SHEET WG1144 Central Mount

Glass Door Hinge Wall-to-Glass Fixing, Central Mounted with Adjustable Closing Lotus Style#1 Clamp Plates

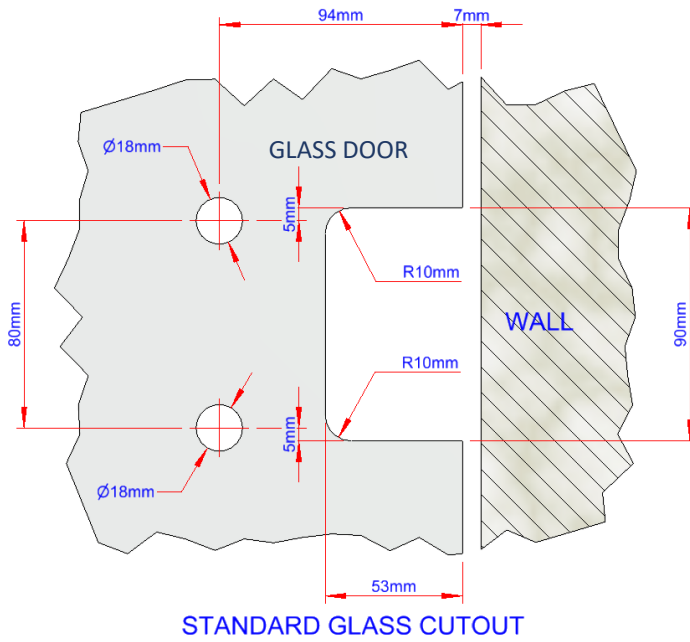

STANDARD  
APPLICATION  
Wall-to-Glass Gap = 7mm

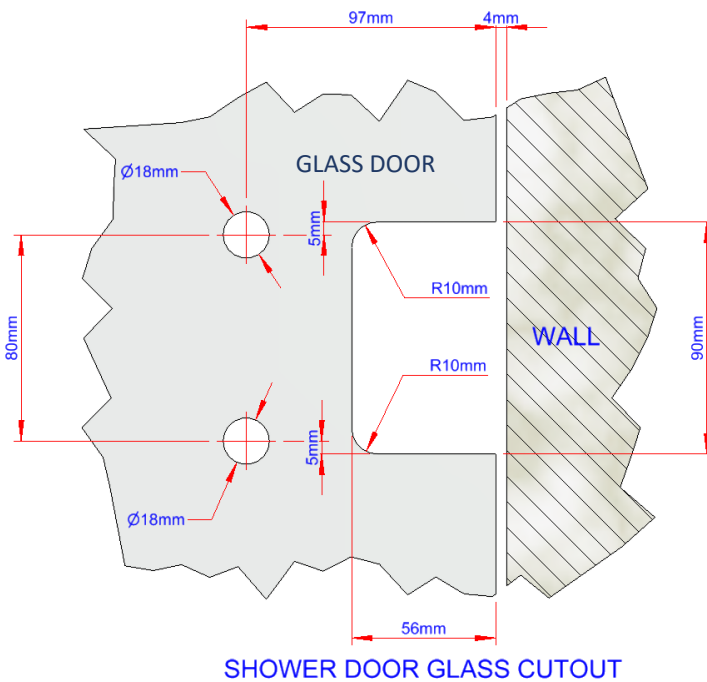

SHOWER DOOR  
APPLICATION  
Wall-to-Glass Gap = 4mm

*Insignia Collection*

Luxury Glass Door Hinges

DATA SHEET WG1144 Central Mount

Glass Door Hinge Wall-to-Glass Fixing, Central Mounted with Adjustable Closing Lotus Style#1 Clamp Plates

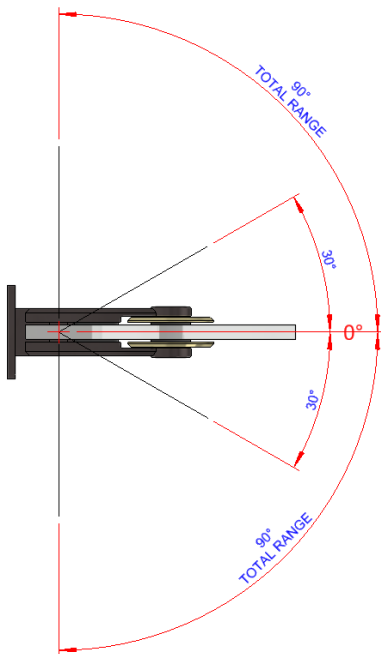

Automatic closing action from 30°  
0° point closing adjustable

*Insignia Collection*

Luxury Glass Door Hinges

DATA SHEET WG1144 Central Mount

Glass Door Hinge Wall-to-Glass Fixing, Central Mounted with Adjustable Closing  
Lotus Style#1 Clamp Plates

Lotus Style#1 Clamp Plate Finish Options



Polished Brass



Polished Nickel



Polished Light Brass

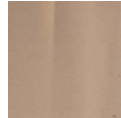

Polished Light Copper



Polished Chrome



Polished Light Gold



Satin Brass

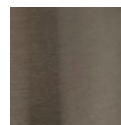

Satin Nickel

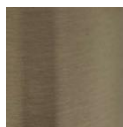

Satin Light Brass



Satin Light Copper



Satin Chrome

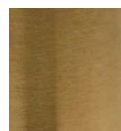

Satin Light Gold

Other Finishes available upon request

For technical reasons connected with media representations, the colours shown may not be exact matches of the finished product.

*Insignia Collection*

Luxury Glass Door Hinges

DATA SHEET WG1144 Central Mount

Glass Door Hinge Wall-to-Glass Fixing, Central Mounted with Adjustable Closing Lotus Style#1 Clamp Plates

Hinge Body Finish Options

Metallic Coated Finish  
Aged Brass

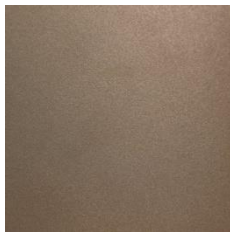

Metallic Coated Finish  
Dark Brass

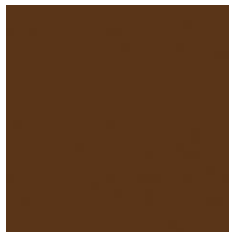

Metallic Coated Finish  
Bronze Bagana



Metallic Coated Finish  
Bronze Glencoe

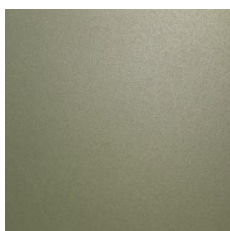

Metallic Coated Finish  
Dark Bronze

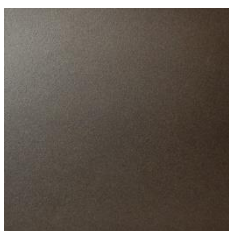

Metallic Coated Finish  
Light Bronze



Other Finishes available upon request

For technical reasons connected with media representations, the colours shown may not be exact matches of the finished product.